

# MagnaPro Twin 1000-1500 Vortex (3-phase)

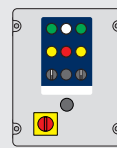

## SYSTEM OVERVIEW



Control panel with four floats

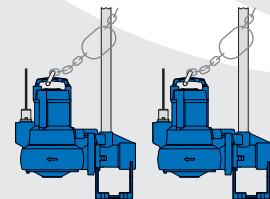
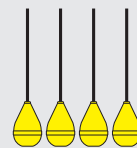

2 pedestal-mounted manual pumps with guide rails and lifting chains

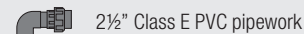

2 1/2" Class E PVC pipework



110 mm inlet



2 1/2" brass valves



110 mm cable duct



90 mm HDPE discharge



110 mm vent

The MagnaPro Twin 1000-1500 Vortex is a fully automatic packaged pumping station suitable for pumping grey, surface, storm or foul water to a higher level when gravity drainage is not possible and/or economical to install.

The system provides up to 705 litre storage capacity depending on inlet depth. It is ideal for accepting waste from an extension, outbuilding, basement or similar.

Its three-phase pumps provide higher torque to minimise blockages, increased energy efficiency, and improved reliability compared to a single-phase pump. Their vortex impellers provide reliable and effective pumping of grey and foul water.

The system comprises our award-winning polyethylene MagnaPro chamber, internal Class E PVC pipework and fittings, brass valves, control panel, float switches, two pedestal-mounted manual pumps with vortex impellers, and an external compression adaptor for discharge to 90 mm OD HDPE.

It is easy to install as inlets can be positioned to your site's requirements. Inlet information to be supplied at time of order, or can be drilled on site.

An access cover is not included. A range of access covers is available to suit your project requirements.

Our packaged pumping stations are built to last and designed to be easy to service.

## KEY FEATURES

- Vortex impellor for high flow rates
- Twin pumps for backup if one of the pumps fail
- Three-phase pumps for higher torque, increased energy efficiency, and improved reliability
- Up to 705 litres storage capacity
- 60° benching
- Compact chamber for limited space installations
- Ideal for an extension, outbuilding, basement or similar application
- 750 mm x 600 mm clear opening
- Variable inlet positions to suit site
- A range of alarms and remote alerts are available offering peace of mind
- Quick and simple to install

## SPECIFICATIONS

MagnaPro 1000 Vortex systems comply with:

- BS EN 12050-1:2015 Wastewater lifting plants for buildings and sites. Lifting plants for wastewater containing faecal matter.
- BS EN 12050-2:2015 Wastewater lifting plants for buildings and sites. Lifting plants for faecal-free wastewater.

## WASTE TYPE



Grey

Foul

Surface

Storm

## OPTIONAL EXTRAS



Upgraded pumps

Control equipment

Battery backup

External pipework

Remote monitoring

Level controls

Access covers

Kiosks

All our products can be customised to your requirements. For more information and advice please call our Sales Team on 01442 211554.

# MagnaPro Twin 1000-1500 Vortex (3-phase)

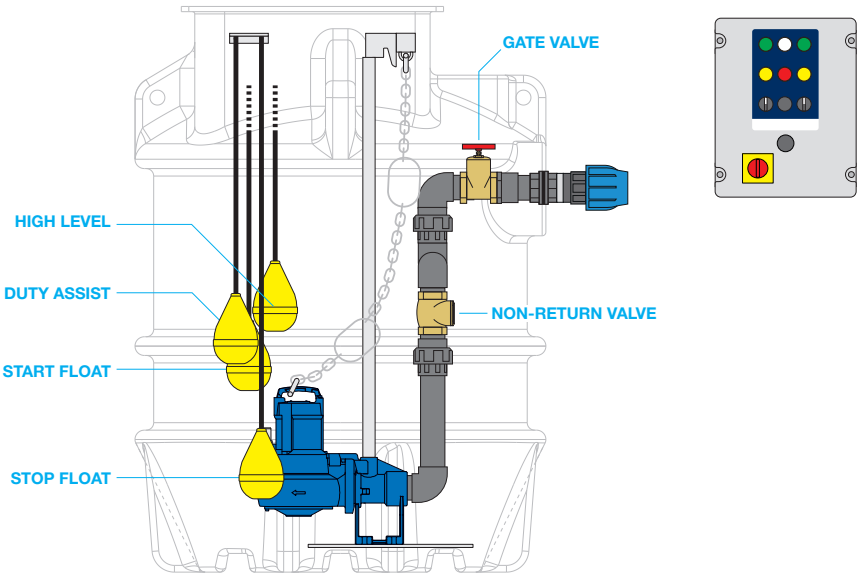

## PUMP SPECIFICATIONS

Number of pumps	Two
Impellor type	Vortex
Control	Manual
Power supply	415 VAC
Rated current per pump	2.8 A
Motor rating (P2) per pump	750 W
Revolutions per min.	2900
Discharge size	DN65
Free passage	60 mm
Max. vertical output per pump	8.2 m
Max. flow rate per pump	8.2 l/s
Max liquid temp.	<40 °C
Cable length	10 m
Weight	26 kg

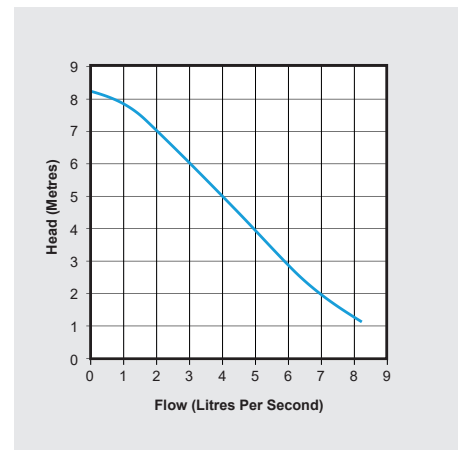

## CHAMBER DIMENSIONS

Shows indicative capacities from lowest inlet invert.

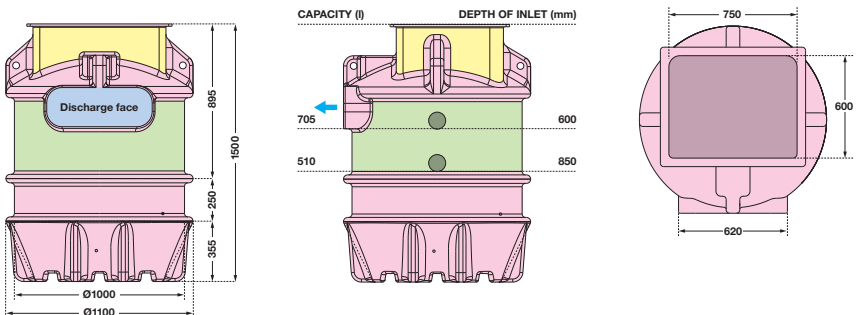

### Permitted connection positions

Discharge only	Inlet location allowed	Cable ducts and vents only	No drilling allowed
----------------	------------------------	----------------------------	---------------------

## CHAMBER SPECIFICATIONS

Internal pipework	2½" OD Class E PVC
Discharge pipework	90 mm OD HDPE
Lifting eyes	4 no
Maximum storage capacity	705 litres
Chamber material	Tank-grade polyethylene
Dimensions (Ø x H)	1100 x 1500 mm
Clear opening	750 x 600 mm

## CONTROL PANEL SPECIFICATIONS

Enclosure	ABS plastic, IP54
Volt-free contact	No
Voltage	415 V
Voltd contact	24 V
Dimensions (H x W x D)	380 x 300 x 180 mm

# DELIVERING PUMPED AND DRAINAGE SOLUTIONS FOR OVER 30 YEARS

- Packaged pumping stations**
- Waste water pumping systems**
- Macerators and macerating toilets**
- Floor mounted pumping stations**
- Fat, oil and grease separating systems**
- Rainwater harvesting systems**
- Battery backup systems**
- Adoptable pumping stations**
- Submersible pumps**
- Accessories**



We provide pumped and drainage products and services to the public and private sectors, including residential, commercial, hospitality and retail.

We are proud of the long-term relationships we have built with our clients and partners, delivering cost effective, robust and dependable products and services.

### 12-MONTH GUARANTEE

Your products are protected by a 12-month guarantee. Please refer to our Terms and Conditions at [www.edincare.com](http://www.edincare.com)

### HOW TO ORDER

Order online at [www.edincare.com](http://www.edincare.com)  
 Call Sales on 01442 211554  
 Email [sales@edincare.com](mailto:sales@edincare.com)

### PROJECT SERVICES

- Project design
- Site surveys
- Installations
- Refurbishments

### AFTERSALES SERVICES

- Planned servicing
- Emergency call outs
- Commissioning
- Monitoring

### DRAINAGE SERVICES

- Tankering
- Jetting
- Drainage CCTV
- Surveys
- Cleaning and de-scaling
- Structural repairs
- Excavations
- Root cutting

### [www.edincare.com](http://www.edincare.com)

- Discover our products and services
- Order products online
- Case studies and articles
- Brochures and technical documents

## Protect your property with an Edincare Service Agreement

As with all pumped and drainage systems, regular maintenance is essential to ensure optimum performance and minimal downtime. Our Service Agreements comprises planned preventive maintenance visits at an agreed frequency, we also service other manufacturers' equipment regardless of type, make and age.

- ✓ Validates your building insurance
- ✓ Reduces the risk of failure
- ✓ Increases the life expectancy of your equipment
- ✓ Priority callouts and 24/7 out-of-hours service
- ✓ Reduced rates for emergency call outs
- ✓ Flexible payment options (Direct Debit)



+44 (0)1442 211554  
[info@edincare.com](mailto:info@edincare.com)

[www.edincare.com](http://www.edincare.com)  
[edincarepumps](https://www.linkedin.com/company/edincarepumps)

Unit 8, Heron Business Park, Eastman Way,  
 Hemel Hempstead, Hertfordshire, HP2 7FW

Part of the Edincare Group of Companies [www.edincaregroup.com](http://www.edincaregroup.com)



Our policy is one of continuous product improvement, we reserve the right to change specifications and prices without prior notice. All information is given in good faith. No responsibility can be accepted for errors, omissions or incorrect assumptions. © Omni Pump International Ltd t/a Edincare Pumps & Edincare Drains. All rights reserved.