

MagnaPro 1250-1500 Macerator (1-phase)

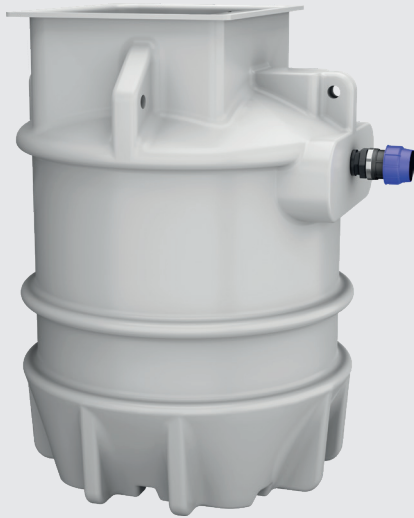

SYSTEM OVERVIEW

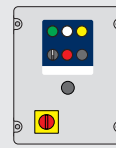

Control panel with three floats

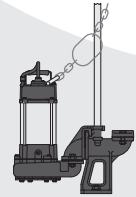
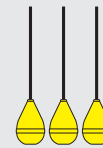

1 pedestal-mounted manual pump with guide rails and lifting chain



2" Class E PVC pipework



110 mm inlet



2" brass valves



110 mm cable duct



63 mm MDPE discharge



110 mm vent

The MagnaPro 1250-1500 Macerator is a fully automatic packaged pumping station suitable for pumping grey and foul water to a higher level when gravity drainage is not possible or economical to install.

The system provides up to 1100 litre storage capacity depending inlet depth. It is ideal for accepting waste from an extension, outbuilding, basement or similar.

The pump's cutting action offers reliable and effective pumping of grey and foul water.

The system comprises our award-winning polyethylene MagnaPro chamber, internal Class E PVC pipework and fittings, brass valves, control panel, float switches, a pedestal-mounted manual pump with grinder impellor, and an external compression adaptor for discharge to 63 mm OD MDPE.

It is easy to install as inlets can be positioned to your site's requirements. Inlet information to be supplied at time of order, or can be drilled on site.

An access cover is not included. A range of access covers is available to suit your project requirements.

Our packaged pumping stations are built to last and designed to be easy to service.

KEY FEATURES

- The pump's cutting action and small solids clearance reduces the chance of blockages
- Up to 1100 litres storage capacity
- 60° benching
- Compact chamber for limited space installations
- Ideal for an extension, outbuilding, basement or similar application
- 900 mm x 600 mm clear opening
- Variable inlet positions to suit site
- A range of alarms and remote alerts are available offering peace of mind
- Quick and simple to install

SPECIFICATIONS

MagnaPro 1250 Macerator systems comply with:

- BS EN 12050-1:2015 Wastewater lifting plants for buildings and sites. Lifting plants for wastewater containing faecal matter.

WASTE TYPE



Grey

Foul

OPTIONAL EXTRAS



Upgraded pumps

Control equipment

Battery backup

External pipework

Remote monitoring

Level controls

Access covers

Kiosks

All our products can be customised to your requirements. For more information and advice please call our Sales Team on 01442 211554.

MagnaPro 1250-1500 Maceratorator (1-phase)

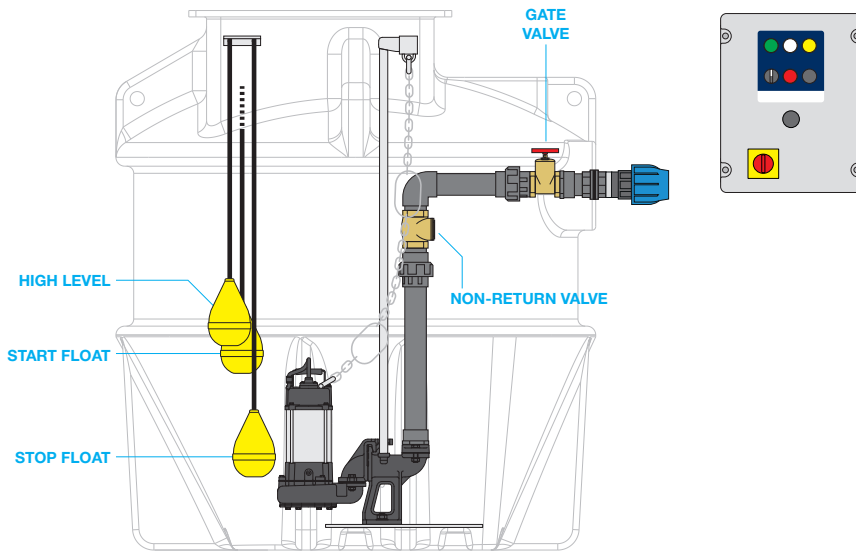

PUMP SPECIFICATIONS

Number of pumps	One
Impellor type	Grinder
Control	Manual
Power supply	230 VAC
Rated current	5.2 A
Motor rating (P2)	750 W
Revolutions per min.	3000
Discharge size	2"
Free passage	6 mm
Max. vertical output	14 m
Max. flow rate	6.6 l/s
Max liquid temp.	<40 °C
Cable length	10 m
Weight	18 kg

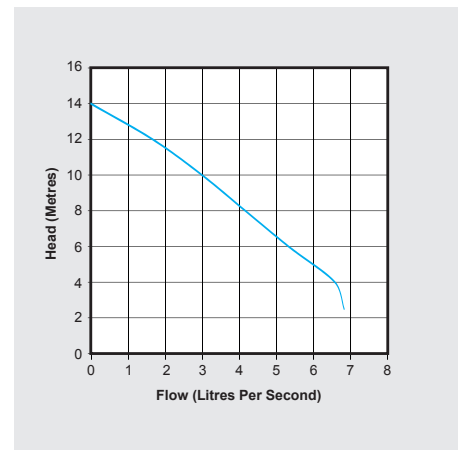

CHAMBER DIMENSIONS

Shows indicative capacities from lowest inlet invert.

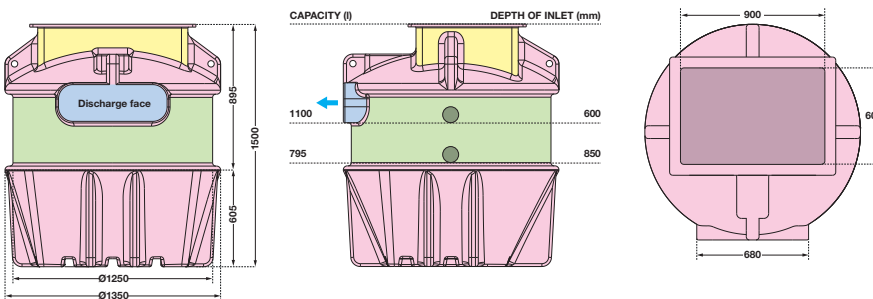

Permitted connection positions

Discharge only	Inlet location allowed	Cable ducts and vents only	No drilling allowed
----------------	------------------------	----------------------------	---------------------

CHAMBER SPECIFICATIONS

Internal pipework	2½" OD Class E PVC
Discharge pipework	90 mm OD MDPE
Lifting eyes	4 no
Maximum storage capacity	1100 litres
Chamber material	Tank-grade polyethylene
Dimensions (Ø x H)	1350 x 1500 mm
Clear opening	900 x 600 mm

CONTROL PANEL SPECIFICATIONS

Enclosure	ABS plastic, IP54
Volt-free contact	No
Voltage	240 V
Voltd contact	24 V
Dimensions (H x W x D)	380 x 300 x 180 mm

DELIVERING PUMPED AND DRAINAGE SOLUTIONS FOR OVER 30 YEARS

- Packaged pumping stations**
- Waste water pumping systems**
- Macerators and macerating toilets**
- Floor mounted pumping stations**
- Fat, oil and grease separating systems**
- Rainwater harvesting systems**
- Battery backup systems**
- Adoptable pumping stations**
- Submersible pumps**
- Accessories**



We provide pumped and drainage products and services to the public and private sectors, including residential, commercial, hospitality and retail.

We are proud of the long-term relationships we have built with our clients and partners, delivering cost effective, robust and dependable products and services.

12-MONTH GUARANTEE

Your products are protected by a 12-month guarantee. Please refer to our Terms and Conditions at www.edincare.com

HOW TO ORDER

Order online at www.edincare.com
 Call Sales on 01442 211554
 Email sales@edincare.com

PROJECT SERVICES

- Project design
- Site surveys
- Installations
- Refurbishments

AFTERSALES SERVICES

- Planned servicing
- Emergency call outs
- Commissioning
- Monitoring

DRAINAGE SERVICES

- Tankering
- Jetting
- Drainage CCTV
- Surveys
- Cleaning and de-scaling
- Structural repairs
- Excavations
- Root cutting

www.edincare.com

- Discover our products and services
- Order products online
- Case studies and articles
- Brochures and technical documents

Protect your property with an Edincare Service Agreement

As with all pumped and drainage systems, regular maintenance is essential to ensure optimum performance and minimal downtime. Our Service Agreements comprises planned preventive maintenance visits at an agreed frequency, we also service other manufacturers' equipment regardless of type, make and age.

- ✓ Validates your building insurance
- ✓ Reduces the risk of failure
- ✓ Increases the life expectancy of your equipment
- ✓ Priority callouts and 24/7 out-of-hours service
- ✓ Reduced rates for emergency call outs
- ✓ Flexible payment options (Direct Debit)



+44 (0)1442 211554
info@edincare.com

www.edincare.com
[edincarepumps](https://www.facebook.com/edincarepumps)

Unit 8, Heron Business Park, Eastman Way,
 Hemel Hempstead, Hertfordshire, HP2 7FW

Part of the Edincare Group of Companies www.edincaregroup.com



Our policy is one of continuous product improvement, we reserve the right to change specifications and prices without prior notice. All information is given in good faith. No responsibility can be accepted for errors, omissions or incorrect assumptions. © Omni Pump International Ltd t/a Edincare Pumps & Edincare Drains. All rights reserved.