

SumpFlush Twin 800-1500 c/w Timer Control Panel

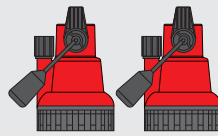

SYSTEM OVERVIEW



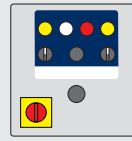

Two free-standing automatic pumps



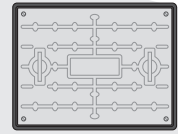

10-hour changeover control panel with high level alarm and volt-free contact



Access cover, solid top, locking, galvanised steel, PP frame, FACTA A

-  110 mm inlet
-  50 mm cable duct
-  110 mm inlet

-  1 1/4" Class E PVC pipework
-  1 1/4" Class E PVC discharge
-  1 1/4" brass valves



The SumpFlush Twin 800-1500 is a fully automatic wastewater pumping system suitable for pumping surface and/or ground water to a higher level when gravity drainage is not possible and/or economical to install.

The system provides up to 450 litre storage capacity depending inlet depth. It can accept waste from car parks, car washes, floor areas, down pipes, cavity membrane systems or similar.

It is not suitable for receiving foul waste. Contact our Sales Team for advice on a suitable foul water packaged pumping stations for your property.

The system consists of a polyethylene tank, Class E PVC internal pipework with brass valves, two automatic wastewater submersible pumps and a solid top, locking, galvanised steel access cover (FACTA A).

The control panel balances the wear between the two pumps, and provides a high level alarm and volt-free contacts for remote monitoring.

It discharges to solvent welded 1 1/4" Class E PVC. Optional discharge reducer kits can increase external discharge diameter to 1 1/2" or 2" to reduce friction loss. Compression fittings are also available for discharging to MDPE pipework.

It is easy to install as inlets can be positioned to your site's requirements. Inlet information to be supplied at time of order, or can be drilled on site.

KEY FEATURES







- Vortex impellor for high flow rates
- Twin pumps for backup if one of the pumps fail
- Control panel for timed changeover, high level alarm and volt-free contacts
- Up to 450 litres storage capacity
- Ideal for an extension, outbuilding, basement or similar
- 600 mm x 450 mm clear opening
- Variable inlet positions to suit site
- A range of battery backup systems are available
- A range of alarms and remote alerts are available
- Quick and simple to install

WASTE TYPE

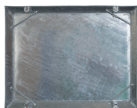

For groundwater and surface water applications where inflow cannot be controlled, a battery backup system should be used, in accordance with BS 8102:2022 and PCA Guidelines. Battery backup systems can be purchased to your specification.

RECOMMENDED ACCESSORIES

<p>UPS 2000</p>  <p>#29161</p>	<p>PowerShield 500</p>  <p>#37501</p>	<p>Inlay access cover</p>  <p>#18004</p>	<p>Additional inlet</p> <p>110 mm 50 mm</p>  <p>#17010 #17012</p>	<p>Discharge reducer kit</p> <p>1 1/2" to 1 1/4" 2" to 1 1/4"</p>  <p>#8203 #8202</p>	<p>Compression adaptor</p> <p>for 32 mm OD MDPE</p>  <p>#27090</p>
--	---	--	---	--	--

All our products can be customised to your requirements. For more information and advice please call our Sales Team on 01442 211554.

SumpFlush Twin 800-1500 c/w Timer Control Panel

TYPICAL INSTALLATION

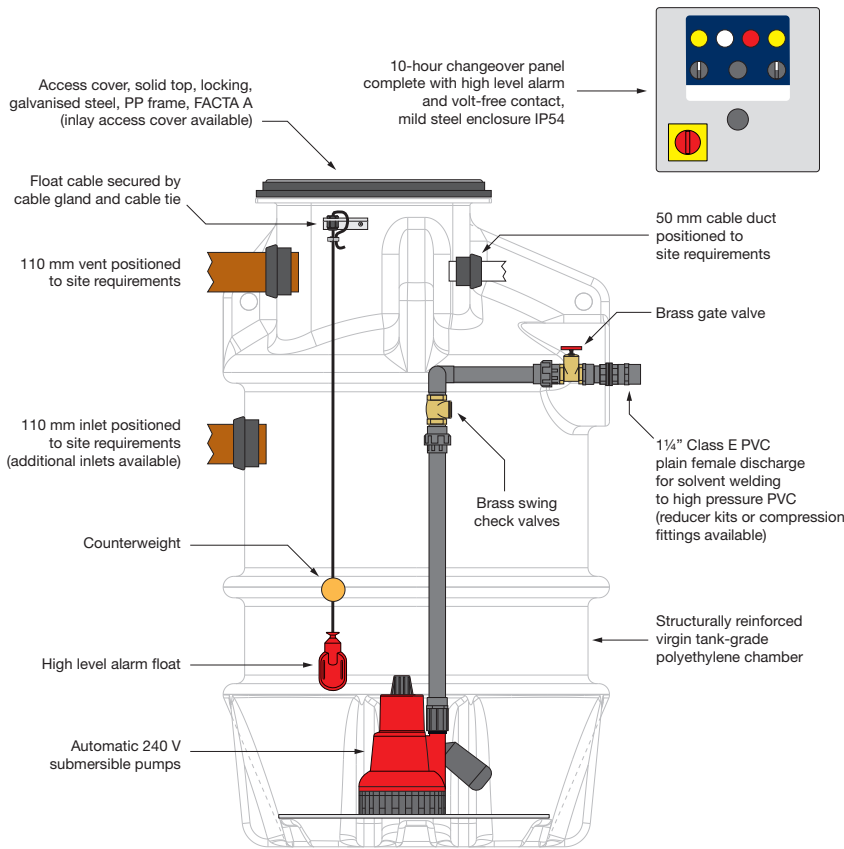

PUMP SPECIFICATIONS

Number of pumps	Two
Impellor type	Vortex
Control	Automatic
Power supply	230 VAC
Rated current per pump	1.9 A
Motor rating (P2) per pump	180 W
Revolutions per min.	2800
Discharge size	1 1/4"
Free passage	10 mm
Max. vertical output per pump	6.8 m
Max. flow rate per pump	2.9 l/s
Max liquid temp.	<40 °C
Cable length	5 m
Weight	5.2 kg

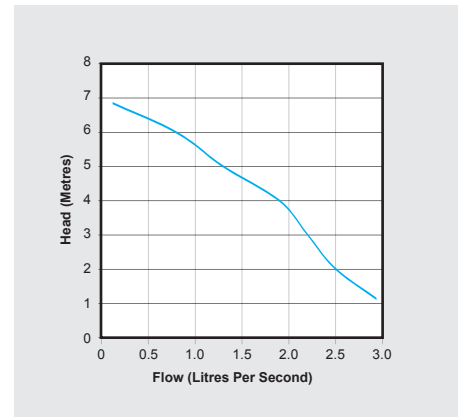

CHAMBER DIMENSIONS

Shows indicative capacities from lowest inlet invert.

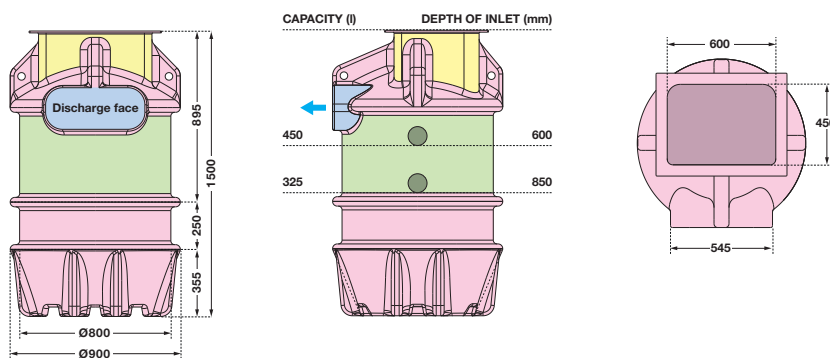

Permitted connection positions

Discharge only	Inlet location allowed	Cable ducts and vents only	No drilling allowed
----------------	------------------------	----------------------------	---------------------

CHAMBER SPECIFICATIONS

Internal pipework	1 1/4" OD Class E PVC
Discharge pipework	1 1/4" OD Class E PVC
Lifting eyes	4 no
Maximum storage capacity	450 litres
Chamber material	Tank-grade polyethylene
Dimensions (Ø x H)	900 x 1500 mm
Clear opening	600 x 450 mm

ACCESS COVER

Material	Galvanised steel, PP frame
Cover type	Solid top
Locking	4 screws
Loading	Pedestrian duty FACTA A
Clear opening (H x W)	600 x 450 mm
Dimensions (L x W x D)	663 x 513 x 30 mm

DELIVERING PUMPED AND DRAINAGE SOLUTIONS FOR OVER 30 YEARS

- Packaged pumping stations**
- Waste water pumping systems**
- Macerators and macerating toilets**
- Floor mounted pumping stations**
- Fat, oil and grease separating systems**
- Rainwater harvesting systems**
- Battery backup systems**
- Adoptable pumping stations**
- Submersible pumps**
- Accessories**



We provide pumped and drainage products and services to the public and private sectors, including residential, commercial, hospitality and retail.

We are proud of the long-term relationships we have built with our clients and partners, delivering cost effective, robust and dependable products and services.

12-MONTH GUARANTEE

Your products are protected by a 12-month guarantee. Please refer to our Terms and Conditions at www.edincare.com

HOW TO ORDER

Order online at www.edincare.com
 Call Sales on 01442 211554
 Email sales@edincare.com

PROJECT SERVICES

- Project design
- Site surveys
- Installations
- Refurbishments

AFTERSALES SERVICES

- Planned servicing
- Emergency call outs
- Commissioning
- Monitoring

DRAINAGE SERVICES

- Tankering
- Jetting
- Drainage CCTV
- Surveys
- Cleaning and de-scaling
- Structural repairs
- Excavations
- Root cutting

www.edincare.com

- Discover our products and services
- Order products online
- Case studies and articles
- Brochures and technical documents

Protect your property with an Edincare Service Agreement

As with all pumped and drainage systems, regular maintenance is essential to ensure optimum performance and minimal downtime. Our Service Agreements comprises planned preventive maintenance visits at an agreed frequency, we also service other manufacturers' equipment regardless of type, make and age.

- ✓ Validates your building insurance
- ✓ Reduces the risk of failure
- ✓ Increases the life expectancy of your equipment
- ✓ Priority callouts and 24/7 out-of-hours service
- ✓ Reduced rates for emergency call outs
- ✓ Flexible payment options (Direct Debit)



+44 (0)1442 211554
info@edincare.com

www.edincare.com
[edincarepumps](https://www.facebook.com/edincarepumps)

Unit 8, Heron Business Park, Eastman Way,
 Hemel Hempstead, Hertfordshire, HP2 7FW

Part of the Edincare Group of Companies www.edincaregroup.com



Our policy is one of continuous product improvement, we reserve the right to change specifications and prices without prior notice. All information is given in good faith. No responsibility can be accepted for errors, omissions or incorrect assumptions. © Omni Pump International Ltd t/a Edincare Pumps & Edincare Drains. All rights reserved.