

Magna SS Twin 1250/11/80

The Magna SS Twin 1250/11/80 is a fully automatic floor mounted pumping station offering dual horizontally mounted dry well pumps and a robust 1250 litre stainless steel chamber.

The system is suitable for pumping both foul and storm water to a higher level when gravity drainage is not possible and/or economical to install.

Manufactured in robust stainless steel with ductile iron pipe work the MagnaSS couples top level aesthetics with hard wearing durability making it ideal for high level commercial installation.

The system is supplied with a DN80 outlet and uses vortex impellers. The control panel upstand also ensures the system can be installed in as compact an area as possible. The system is only suitable for three phase power.

KEY FEATURES

- 1250 litre storage capacity
- Robust and attractive stainless steel chamber system
- Automatic twin horizontally mounted vortex pumps
- DN80 outlet connection
- Space saving control panel upstand
- Bespoke systems available contact our sales team to discuss your project



PUMP CURVE

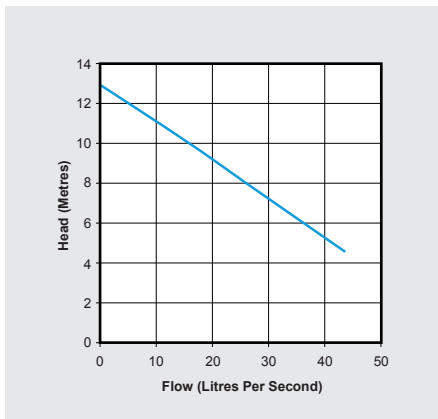

DIMENSIONS (mm)

Product	Length	Width	Height
Magna SS 1250/11/80	2037	1000	1450
Chamber	1000	1000	1250

Product	Height	Width	Depth
Control panel	500	400	200

TECHNICAL DATA

MAGNA SS 1250/11/80	
Power supply	415 VAC
Number of pumps	2
Impellor type	Vortex
Starting current	36A
Starting torque	28.4Nm
Rated current	6.4A
Rated torque	19.6Nm
Motor rating	3000W
Frequency	50Hz
Revolutions per min.	1450rpm
Max vertical output	11m
Max flow rate	42 l/s
Free passage	75mm
Input size	DN100
Discharge size	DN80
Tank capacity	1250 litres
Tank material	Stainless steel
Lifting eyes	2no
Level control type	Probes
Number of level controls	5no

CONTROL PANEL	
Material	Metal
Volt free contact	Yes
Voltage	415 VAC
Voltage contact	No

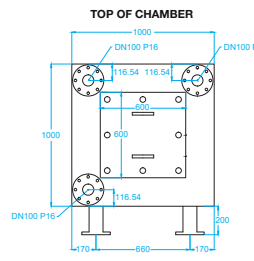
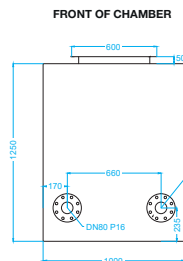
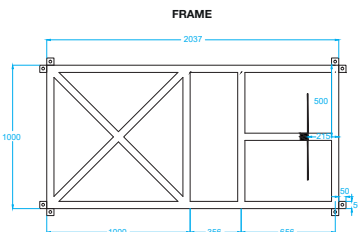
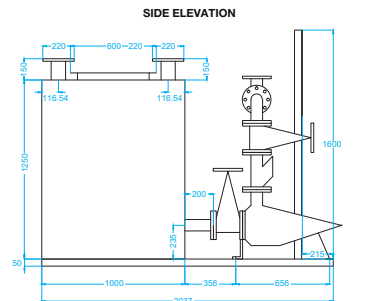

SUITABLE FOR



WASTE TYPE

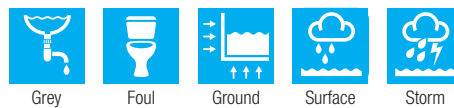

OPTIONAL EXTRAS

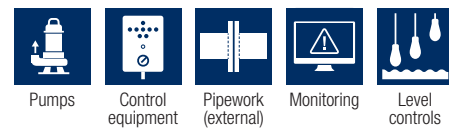

All our products can be customised to your requirements. For more information on this please contact our sales team on 01442 211554.

DELIVERING PUMPED AND DRAINAGE SOLUTIONS FOR OVER 25 YEARS

Packaged pumping stations

Waste water pumping systems

Macerators and macerating toilets

Floor mounted pumping stations

Fat, oil and grease separating systems

Rainwater harvesting systems

Battery backup systems

Adoptable pumping stations

Accessories



We provide pumped and drainage products and services to the public and private sectors, including residential, commercial, hospitality and retail.

We are proud of the long-term relationships we have built with our clients and partners, delivering cost effective, robust and dependable products and services.

12-MONTH GUARANTEE

Your products are protected by a 12-month guarantee. Please refer to our Terms and Conditions at www.edincare.com

HOW TO ORDER

Order online at www.edincare.com
 Call Sales on 01442 211554
 Email sales@edincare.com

PROJECT SERVICES

- Project design
- Site surveys
- Installations
- Refurbishments

AFTERSALES SERVICES

- Planned servicing
- Emergency call outs
- Commissioning
- Monitoring

DRAINAGE SERVICES

- Tankering
- Jetting
- Drainage CCTV
- Surveys

www.edincare.com

- Discover our products and services
- Order products online
- Case studies and articles
- Brochures and technical documents

Protect your property with an Edincare Service Agreement

As with all pumped and drainage systems, regular maintenance is essential to ensure optimum performance and minimal downtime. Our Service Agreements comprises planned preventive maintenance visits at an agreed frequency, we also service other manufacturers' equipment regardless of type, make and age.

- ✓ Validates your building insurance
- ✓ Reduces the risk of failure
- ✓ Increases the life expectancy of your equipment
- ✓ Priority callouts and 24/7 out-of-hours service
- ✓ Reduced rates for emergency call outs
- ✓ Flexible payment options (Direct Debit)



+44 (0)1442 211554
info@edincare.com

www.edincare.com
[edincarepumps](https://www.linkedin.com/company/edincarepumps)

Unit 8, Heron Business Park, Eastman Way,
 Hemel Hempstead, Hertfordshire, HP2 7FW

Part of the Edincare Group of Companies www.edincaregroup.com



Our policy is one of continuous product improvement, we reserve the right to change specifications and prices without prior notice. All information is given in good faith. No responsibility can be accepted for errors, omissions or incorrect assumptions. © Omni Pump International Ltd t/a Edincare Pumps & Edincare Drains. All rights reserved.